



Manual

Watermaker Models AC

Instructions for installing, operating, and maintaining your
watermaker.

Version 3.1

Published on 27.11.2024

Manufactured and distributed by Ocean-Spring Watermakers e.K.

Owner: Julian Schlichtenmayer Gartenstr. 95/3, 73430 Aalen, Germany

shop@ocean-spring.de

+49 1515 0531832

All contents of this manual are subject to German copyright law.

Duplication, editing, distribution or use outside the limits of copyright law require the permission of the author. The author and holder of the copyright is Ocean-Spring Watermakers e.K.

Table of contents

1. Intended Use & Compliance	3
2. Scope of delivery	4
3. Specifications	5
4. Warnings	7
5. Operation	8
<i>Switching on and off</i>	8
<i>Flushing</i>	9
<i>Preservation & winterization</i>	9
6. Maintenance	12
<i>Pre-filter replacement</i>	12
<i>Oil change high-pressure pump</i>	12
<i>Cleaning of the membrane</i>	13
<i>Changing the membrane</i>	14
<i>Pressure Regulator maintenance</i>	15
7. Installation	16
<i>Installation Location & Notes</i>	16
<i>Seawater inlet</i>	17
<i>Installation of the filter housings</i>	17
<i>Mounting the pumps</i>	18
<i>Mounting control panel</i>	19
<i>Mounting membrane unit</i>	21
<i>Installation of hose lines</i>	22
<i>Product water pipes</i>	23
<i>High-pressure connection</i>	23
<i>Electrical connections</i>	26
8. Documentation Attachment	27
<i>Electrical wiring diagram</i>	27
<i>Water Flow Chart</i>	28
<i>Dimensions of the main components</i>	29
<i>Spare parts list high-pressure pump</i>	35

1. Intended Use & Compliance

The plant is designed for desalination of seawater for the production of fresh water.
The facility is intended for the installation of pleasure boats and privately used yachts.

Declaration of Conformity

The manufacturer confirms that the product mentioned conforms to the following EU directives.

If the product is changed without our consent, this declaration becomes invalid.

Product: Watermaker, Models AC 230V

Manufacturer:

Ocean-Spring Watermakers e.K.

Julian Schlichtenmayer

Gartenstr. 95/3

73430 Aalen

Fulfilled directives:

- 2006/42/EU Machine directive; 17.05.2006
- 2014/35/EU Low voltage directive; 26.02.2014
- 2011/65/EU ROHS; 08.06.2011
- 2014/30/EU EMC; 26.02.2014

Julian Schlichtenmayer

Aalen, 12.08.24

Julian Schlichtenmayer

Owner Ocean-Spring Watermakers e.K.

2. Scope of delivery

Designation	Quantity
Coarse dirt filter housing with insert 100 µm	1
Feed pump 230V	1
Pre-filter housing double with filter cartridges	1
Filter cartridge 20 µm (replacement)	1
Filter cartridge 5 µm (replacement)	1
Filter housing with activated carbon filter	1
Ball valve for rinsing water / Solenoid valve unit (w Autoflush)	1
T-piece with check valves, pre-assembled	1
Hose barbs 1/2" plastic	5
High pressure pump with motor 230V	1
Connection fitting suction side HP pump, pre-assembled	1
Membrane housing with reverse osmosis membrane; 1,2 or 3 membranes depending on the version	1
High pressure hose 6m	1
Screw on fittings for high-pressure hose	2
Junction box 230V	1
Control panel pre-assembled	1
Elbow connector product water 3/8"	4
T-connector product water (for 2/3 membranes) 3/8"	1 / 2 depending on model
Adapter 3/8" push-in connection to 1/2" hose nozzle	2
Maintenance Kit Pressure Regulator: O-Rings 5 Pieces & M2 Screw	1
Hose material low pressure	
PVC Spiral hose 1/2" (3/4" for AC160/200)	10 m
Quick connect line PE 3/8" product water	6 m
Quick connect line PE 6mm test lead	6 m
Fastening material	
Screws 3.9x22 & washers	18
Screws 3.9x13 & Washers	8
Rubber Feet and threaded screws M8x30 for HP Pump	4
Hose clamps	16
Screws 5x20 for fastening membrane housing	4 or 8
Teflon Tape Industrial Grade for Low-Pressure Fittings	1 roll

3. Specifications

Model 65 / 110	
Power consumption ¹	950 W
Output	
Model 65 1 Membrane 2540 ¹	65 l/h +- 10%
Model 110 2 Membranes 2540 ¹	110 l/h +- 10%
Model 80 / 130	
Power consumption ¹	1200 W
Output	
Model 80 1 Membrane 2540 ¹	80 l/h +- 10%
Model 130 2 Membranes 2540 ¹	130 l/h +- 10%
Model 160 / 200	
Power consumption ¹	1800 W
Output	
Model 160 2 Membranes 2540 ¹	160 l/h +- 10%
Model 200 3 Membranes 2540 ¹	200 l/h +- 10%
PH range	2-11
Chlorine tolerance	<0.1ppm
Salt retention capacity	>99.4%
Sound level measured at a distance of 1m	67 dB
Weight	42kg (1 Membrane) / 51 kg (2 Membranes) / 60 kg (3 Membranes)







¹ Specification based on salinity 35000ppm, 25°C water temperature & 55 bar operating pressure

Correction factors for production rate as a function of sea water temperature:

$$\text{Production rate} = \frac{\text{Nominal production rate at } 25\text{ }^{\circ}\text{C}}{\text{correction factor}} P$$

Seawater temperature		Correction factor
$^{\circ}\text{C}$	$^{\circ}\text{F}$	
10	50,0	1,89
11	51,8	1,78
12	53,6	1,68
13	55,4	1,61
14	57,2	1,54
15	59,0	1,47
16	60,8	1,39
17	62,6	1,34
18	64,4	1,29
19	66,2	1,24
20	68,0	1,19
21	69,8	1,15
22	71,6	1,11
23	73,4	1,09
24	75,2	1,04
25	77,0	1,00
26	78,8	0,97
27	80,6	0,94
28	82,4	0,91
29	84,2	0,88
30	86,0	0,85

4. Warnings

 <p>Warning!</p>	<p>Never operate the system unattended. The system is only to be operated by persons who have been instructed in its use.</p> <p>Check the system regularly for leaks and close seacocks after using the system.</p>
 <p>Warning!</p>	<p>The membrane is provided with a preservative when new. If ingested, this can cause health problems such as irritation of the gastrointestinal tract.</p> <p>During initial and re-commissioning, the system must be operated in the discard for 30 minutes before product water is collected.</p>
 <p>Hint!</p>	<p>The watermaker must only be operated in clean seawater. Contamination such as oil and chlorine cannot be ruled out in ports or other closed waters. These contaminants lead to damage to the system, especially the membrane.</p>
 <p>Hint!</p>	<p>The watermaker must be put into operation within 5 months of delivery to avoid damage to the membrane due to drying out.</p>
 <p>Hint!</p>	<p>Only start the system with the pressure control valve fully open to avoid damage! The pressure must be increased slowly when the system is started and slowly reduced before switching off.</p> <p>The operating pressure must be adapted to the salinity of the water. The amount of product water should not exceed the specified values of the system to avoid damage to the membranes.</p> <p>The pressure control valve limits the maximum adjustable pressure to 60 bar. Avoid kinks and squeezings in the high-pressure hoses at all costs. These can lead to increased pressure and damage to the system.</p>
 <p>Hint!</p>	<p>Check the proper condition of the system regularly with regard to leaks and the oil level of the high-pressure pump!</p>
 <p>Hint!</p>	<p>Never completely shut off the product water line, as this can cause damage to the pipe system and the membranes.</p>

5. Operation

Switching on and off

Please note when starting or launching the boat for the first time:

The feed pump is not self-priming! Do not switch on the feed pump until it is completely filled with water.

Bleed the feed line to the high-pressure pump via the bleed screws of the pre-filter housings. As soon as water comes out of the respective bleed screw, you can close it.

Please note when commissioning with a fresh membrane or after preservation:

The preservative, when new and used for extended downtime, must be flushed out of the system before storing product water in your tanks. To do this, let the system work for 10 minutes without pressure and another 20 minutes in the discard.

Switching on the system:

1. Make sure the pressure regulator is fully open.
2. Make sure that the necessary seacocks are open.
3. Switch on the feed pump via the corresponding switch on the control panel.
4. Switch on the high-pressure pump using the appropriate switch on the control panel.
5. Check the pressure indicator of the feed line. The displayed value must not fall below 0 bar.
 - a. If this value is not reached, the pre-filters must be replaced or cleaned.
6. Slowly close the pressure regulator until the necessary operating pressure is reached.
 - a. The necessary pressure depends primarily on the salinity of the respective body of water. For example, at river mouths, make sure to reduce the pressure if necessary. Use the flow value of the product water as a guide. This should not exceed the typical values of your system.
 - b. Atlantic & Mediterranean = approx. 55 bar
 - c. Baltic Sea = approx. 35 bar
7. Let the system work in the reproach at the beginning
 - a. Use the TDS meter to control the salinity of the product water. This should be below 500 ppm
8. Switch the valve of the product water to tank after the salinity provides a satisfactory value.

Switching off the system:

1. Open the pressure regulator until the pressure drops to 0 bar.
2. Switch off the high-pressure pump using the corresponding switch on the control panel.
3. Switch off the feed pump using the corresponding switch on the control panel.
4. Flush the system with fresh water according to the section Flushing
5. Close the necessary seacocks.

If you use the system on a daily basis, you can generally go without fresh water flushing. However, we recommend flushing after each use to maintain the system in the best possible way.

Flushing

If the system is not used for several days, it is mandatory to flush with fresh water to prevent the growth of microorganisms, especially in the membrane.

Flushing should be repeated every 7 days if not in use.
For longer periods of non-use, it is advisable to preserve the system.

Procedure for models with manual flushing:

1. Open the valve on the filter housing for the flush water.
2. The flushing process should take about 2 minutes or use 10 litres of fresh water.
3. Close the valve on the filter housing for the flush water.

Procedure for models with auto-flush:

1. Press the "Flush" switch on the control panel
2. Wait for the fresh water pump to stop working
3. Bring the "Flush" switch back to the 0 position

Note: If the "Flush" switch remains on "I", the flushing process will repeat according to the set cycle – factory value is every 7 days. The times how long the flushing is performed and in between the cycles can be adjusted on the junction box.

Preservation & winterization

If you do not use your system for a long time, or want to make it winter-proof, it must be conserved.

For preservation, we recommend using propylene glycol.

Propylene glycol fulfils two purposes in one: the system is protected against biogrowth in a material-friendly way and frost protection is achieved.

Preservation with this substance protects your plant for up to 12 months of non-use.

Important! Use only undiluted propylene glycol without alcohol. Alcohol leads to damage to the membrane.

60% mixing ratio protects against frost down to about -27°C. For microbial protection, a mixing ratio of at least 25% is required.

Approx. information on the internal volume of the system to calculate the required amount of propylene glycol:

- 1 membrane - 5 l
- 2 membranes - 6 l
- 3 membranes - 7 l

Required amount of propylene glycol for a mixing ratio of 30% (based on residual volume of water in the plant):

- 1 membrane – 1.5 l
- 2 membranes – 2.0 l
- 3 membranes – 2.3 l

Required amount of propylene glycol for a mixing ratio of 60% (based on residual volume of water in plant):

- 1 membrane – 3.0 l
- 2 membranes – 4.0 l
- 3 membranes – 4.6 l

Substances that are not to be used for preservation:

Ethylene glycol

Sodium Disulfite /Sodium Metabisulfite

Conservation process:

1. Flush with fresh water before starting.
2. Connect the feed pump to a hose to be able to suck the preservative out of the container being used.
3. Lead the waste water pipe from the pressure regulator of the control panel into the container with the preservative
4. Fill the suction hose with preservative or water to prime the feed pump. Insert the hose into the container with the preservative with the end closed.
5. Turn on the feed pump and check that the preservative is being sucked in.
6. Switch on the high-pressure pump to flush it completely with the preservative as well as to support the feed pump.
 - a. This is necessary due to the higher viscosity of propylene glycol.
 - b. Attention! Never close the pressure regulator when preserving! Keep the pressure at 0 bar.
7. Leave both pumps on for about 10 minutes.
8. Turn off both pumps.

9. Restore the original hose connections.

If you expect frost, the product water pipes must also be emptied or blown out. If the membrane is mounted upright, it is advisable to dismantle it in order to pour out the product water or to remove the sealing plugs below at the product water outlet.

6. Maintenance

Maintenance item	Intervall	Comment
Check for leaks	With every use	
Check of Strainer	With every use	cleaning in case of contamination
Pre filter change	When 0 bar feed pressure is reached	With low usage the filters are to be change seasonally at least (bacterial growth)
Oil change of pump	yearly / every 300h	First change after initial 50 h
Maintenance pressure regulator	yearly	
Cleaning of membranes	Upon indication see section Cleaning of the membrane	
Inspection of HP pumps seals	1500 h	In case of passed inspection a repeated inspection should be done every 500h until the seals are replaced.

Pre-filter replacement

If the feed pressure drops to 0 bar during operation, this is a sign of dirty pre-filters. This applies in particular to the filter cartridges in the double filter housing between the feed pump and the high-pressure pump.

The coarse dirt filter between the seacock and the feed pump must be checked regularly and cleaned if necessary, regardless of the display.

The coarse dirt filter can be washed out with clean water and reused.

The filter cartridges of the pre-filter unit must be replaced once fully loaded. Preferably use 9 3/4" or 10" filter cartridges with fineness of 20 µm and 5 µm.

Do not use pre-filters containing cellulose. These can decompose and damage the system.

Oil change high-pressure pump

The high-pressure pump is oil-lubricated and this oil must be replaced at regular intervals.

Exchange intervals:

After initial commissioning: 50 h

After that: Every 500 h or annually

Oil to use: Cat Pumps Crankcase Oil ISO 68, or other ISO 68 oils

If you do not use Cat Pump oil, the interval is reduced to:

300 h or annually

To replace the oil:

1. Open the oil filler and oil drain plug and collect the oil with a suitable container.
2. Close the drain plug after no more oil is coming out.

3. Fill in as much oil as you need through the filling opening until the level is at or above the red dot on the sight glass.
4. Close the filler plug.

The waste oil must be disposed of in an environmentally friendly manner.

Cleaning of the membrane

Over the useful life of the watermaker, deposits can form in the membrane, which affect the performance of the system and the quality of the product water.

The use of a membrane cleaner can restore the performance of the system.

Indications for choosing the respective cleaner:

Acidic cleaner for the removal of mineral deposits (including limescale):

- The product water output is reduced
- the TDS may be slightly increased
- There is no foul smell in the product water

Alkaline cleaner to remove biofouling and light oil deposits:

- The product water output is reduced
- the TDS may be slightly increased
- There is a foul smell or taste in the product water
- The watermaker was operated in contaminated water.

Never mix acidic and alkaline cleaners. The products must be used separately.

If you are unsure which cleaner to use, start with the acidic cleaner and use the alkaline cleaner only if the acidic cleaner has not brought any improvement.

Alkaline cleaners typically have a negative impact on the life of the membrane – so use them only when needed.

Procedure:

- Mix the cleaner
 - o Make a 2% solution of the respective cleaner and fresh, chlorine-free water. For only light contamination, a 1% solution may be sufficient.
 - o For a 2% solution, mix 250 g of cleaner with about 12.5 L of water.
 - o For a better effect of the cleaner, it is recommended to use warm water at about 40°C.
- The cleaning solution must now be circulated through the system. Proceed here in the same way as for preservation.
 - o No pressure must be built up during cleaning.
- At the beginning of the cleaning process, discard the first 3 litres of the solution.
- The remaining solution is now to be circulated for at least 60 minutes.

- In the case of heavy contamination, the cleaner can also remain in the system for several hours or overnight.
- Finally, the cleaning solution must be flushed out of the system, either with fresh water or with sea water.

Changing the membrane

If you need to remove or replace the membranes from the membrane housing, proceed as follows:

1. Disconnect the hose connections from the membrane unit.
2. Loosen the nuts of the tie rods and remove the tie rods
3. Pull the end plates to pull the end caps out of the pressure tube.
 - a. Rotary movements help to reduce resistance and make work easier.
 - b. For configurations with 2 or more membranes:
 - i. Start with the end caps for inlet and outlet.
 - ii. On the end plate, remove the screw connection between the end cap and the end plate except for the connection to the inlet/outlet end cap to be removed.
 - iii. Use the end plate as a lever to turn and pull the end cap.
 - iv. Then remove the pressure vessel. Transfer the end plate to the next end cap to be removed
4. Push or pull out the membrane in the direction of the flow of the seawater (see mark on the pressure vessel).
5. Insert the new membrane in the direction of the flow of seawater as shown.
 - a. The membrane has a rubber seal on one side. This must be located on the inlet side of the pressure vessel.
 - b. For membrane units with multiple pressure vessels, make sure that the flow direction points uniformly from the pump-side inlet to the outlet in the direction of the pressure regulator.
6. Reattach the end caps to the end plates and insert them into the pressure tubes.
7. Reassemble the tie rods and nuts
 - a. The nuts should be tightened so that the threaded rods protrude about 1-2 mm each side and the threaded rods do not flap loosely.
 - b. A particularly high preload is not necessary or expedient.

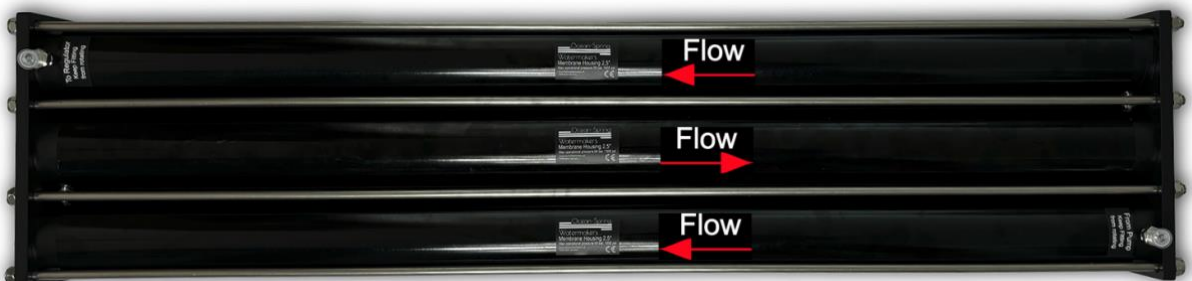

Illustration 1 - Mounting direction membrane in pressure vessel

Pressure Regulator maintenance

The pressure regulator should be disassembled, cleaned and lubricated annually. In the event of a leak, the O-ring of the needle must be replaced. Corresponding replacement is already included in the scope of delivery (O-ring 5x2 NBR 70).

For easy operation, lubricate the thread of the set screw.

Cleaning the valve and replacing the O-ring:

1. Make sure the control valve is fully open
2. Remove the cap by unscrewing it counterclockwise.
3. Remove the compression spring and push pin
4. Screw the supplied M2 screw into the corresponding hole of the needle and pull it out of the valve body with the help of the screw.
5. Clean the hole of the valve body and the needle with a soft, damp cloth and rotating motion.
6. When replacing the O-ring: Dismantle the old O-ring with a rounded object, ideally an O-ring pick (needle tool) to avoid scratching the sealing surfaces. The new O-ring can then be mounted.
7. Lubricate the needle in the area of the O-ring with silicone grease.
8. Put all the components back together in the order in which they were intended.
9. Screw the cap on as far as it will go.

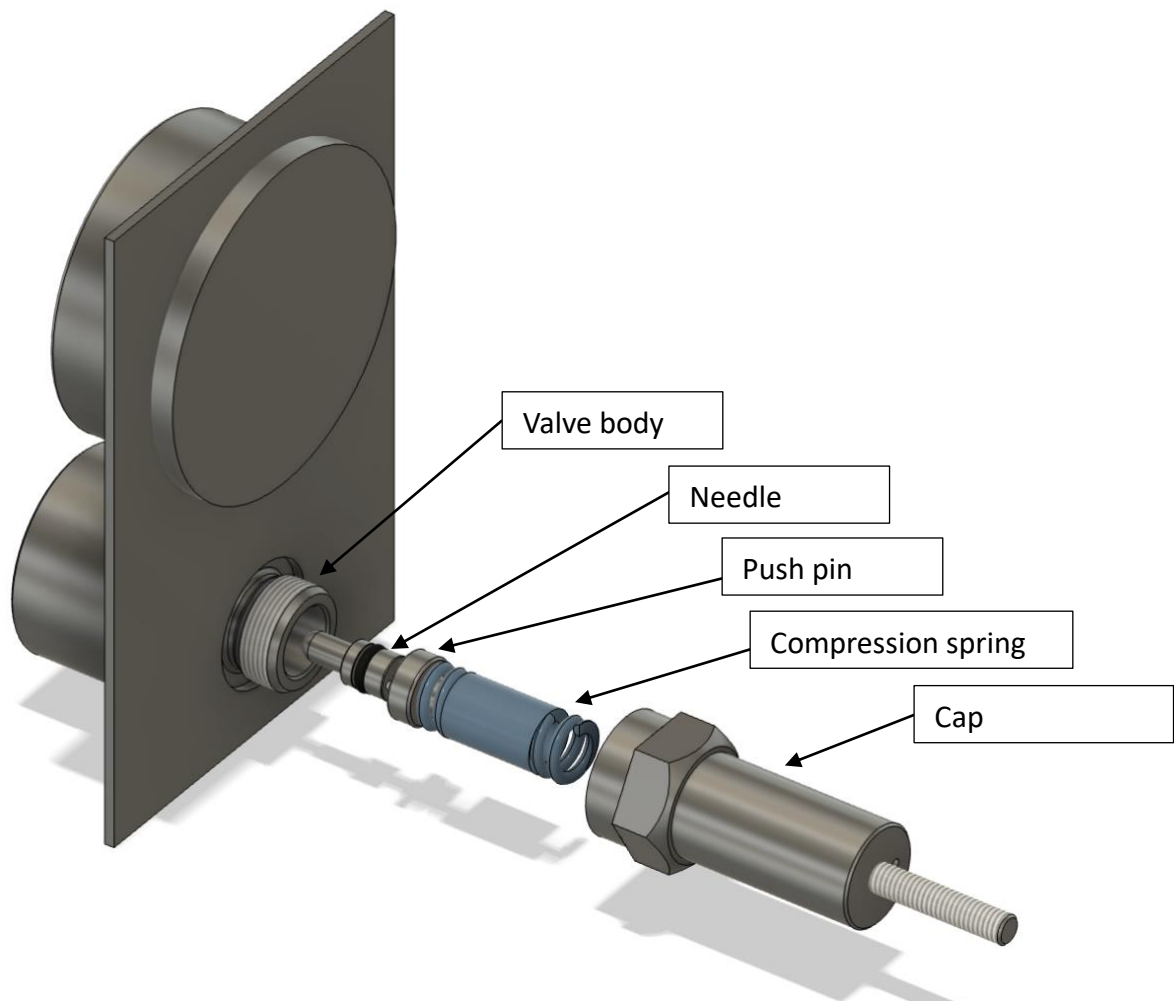



Illustration 2 - Exploded view of the pressure regulator

7. Installation

Installation Location & Notes

The following are relevant installation notes for the respective components of the system. Please read this section carefully before assembling the components. You can choose the arrangement of the components Illustration 3 take from.

 Hint!	To prevent the membrane from drying out, the Watermaker must be put into operation no later than 5 months after the date of delivery, or filled with fresh preservative.
 Hint!	The supplied feed pump and the upstream coarse dirt filter must be installed below the waterline.

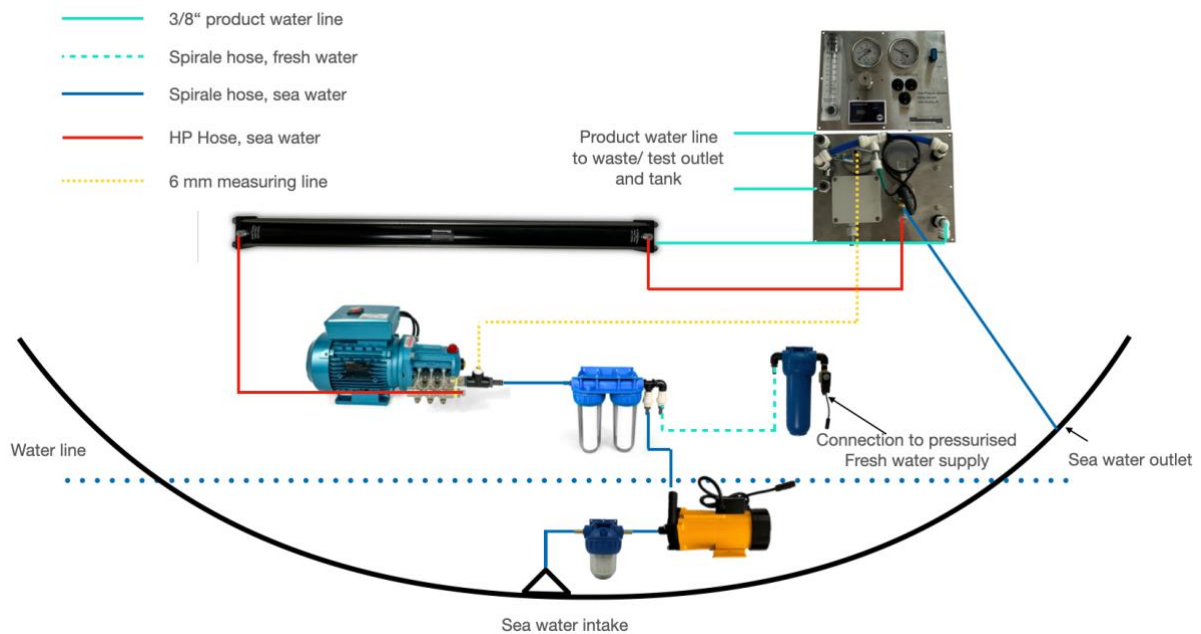



Illustration 3 - Arrangement of the assemblies in relation to the water circuit

Seawater inlet

 <p>Hint!</p>	<p>The seawater inlet must be designed in such a way that air intake is reliably avoided. Air in the system can cause damage to the high-pressure pump and membrane!</p>
--	--



For operation while driving, a seacock with water spoon (see example in Illustration 4) is required. This is to be installed below the waterline as amidships as possible. Be aware of the state of the sea, as well as the movements of your vessel in relation to the location of the seacock, if you want to operate the watermaker. It must be avoided suck in air at any time.

Dimensioning of the Thru-hulls:
Models AC65/110 & DC60: min. ½“
Other models: min. ¾“



Illustration 4 – Through hull with water spoon and marked direction of flow of the water while sailing

Installation of the filter housings

 <p>Hint!</p>	<p>All filter housings have a flow direction that must be considered during installation. To do this, pay attention to the arrow markings visible on the respective housings.</p>
 <p>Hint!</p>	<p>Do not use excessive force to tighten the locking rings of the filter housings.</p>

In order to facilitate the replacement of the pre-filter cartridges, an easily accessible installation location for the pre-filter housings must be selected. The filter housings are to be mounted vertically.

Mounting the pumps

Feed pump



 <p>Hint!</p>	<p>The supplied feed pump is not self-priming and must not be operated dry. Before initial commissioning, make sure that the supply line to the feed pump is completely filled with water.</p>
--	--

The feed pump must be mounted horizontally with its longitudinal axis. The outlet side of the feed pump should face upwards to avoid air pockets.
The hose lines from the seacock to the feed pump should rise continuously to avoid air pockets.



Illustration 5 - Feed pump with horizontally aligned longitudinal axis and inlet, outlet pointing upwards

High Pressure Pump

 <p>Hint!</p>	<p>Remove the sticker on the red oil filler plug after installation. Please check the oil level before commissioning.</p>
 <p>Hint!</p>	<p>The installation space must be ventilated to prevent the engine from overheating.</p>

Depending on the shipping method, the motor and pump are delivered separately. To mount the motor and pump, add the shafts of the two parts with the key.
The high-pressure pump must be mounted horizontally on an appropriate surface. Use the included flexible rubber mounts as well as a sufficiently stiff base to limit the noise level.



Illustration 6 - Oil level above the red marker for the minimum level.

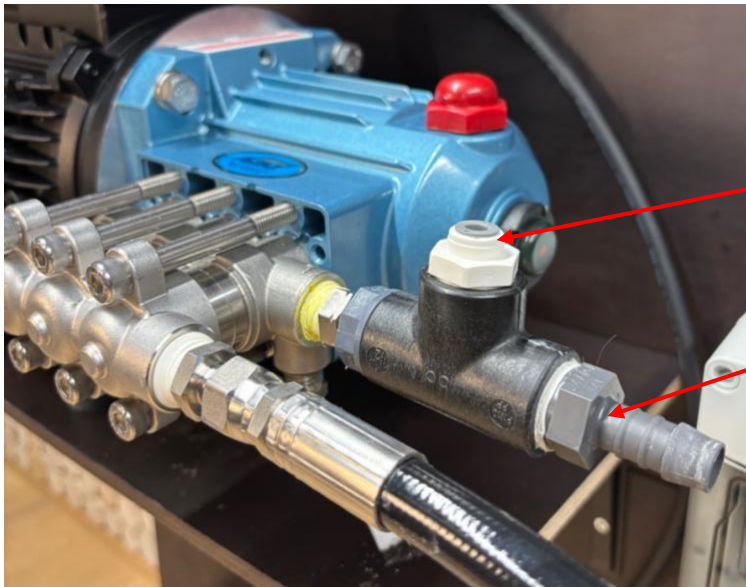

Connection measuring line feed pressure 6mm blue

Connection sea water intake

Illustration 7 – Connections at High pressure pump

Mounting control panel

The control panel requires a rectangular cut-out of 25 x 19 cm.

When connecting the high-pressure line, make sure to counter hold the connecting piece of the control panel with a suitable key in order to keep loads on the control panel low.

The following are to be connected to the control panel:

1. High-pressure line coming from outlet of membrane unit
2. Wastewater hose from pressure control valve to through hull for sea water outlet
3. Quick connect hose 3/8" product water coming from membrane unit
4. Line of product water to tank
5. Line of product water to test/ waste outlet
6. Quick connect hose 6mm from inlet connection HP pump to pressure gauge feed pressure

Connections from the control panel:

7. Electrical connection cable to junction box 230V

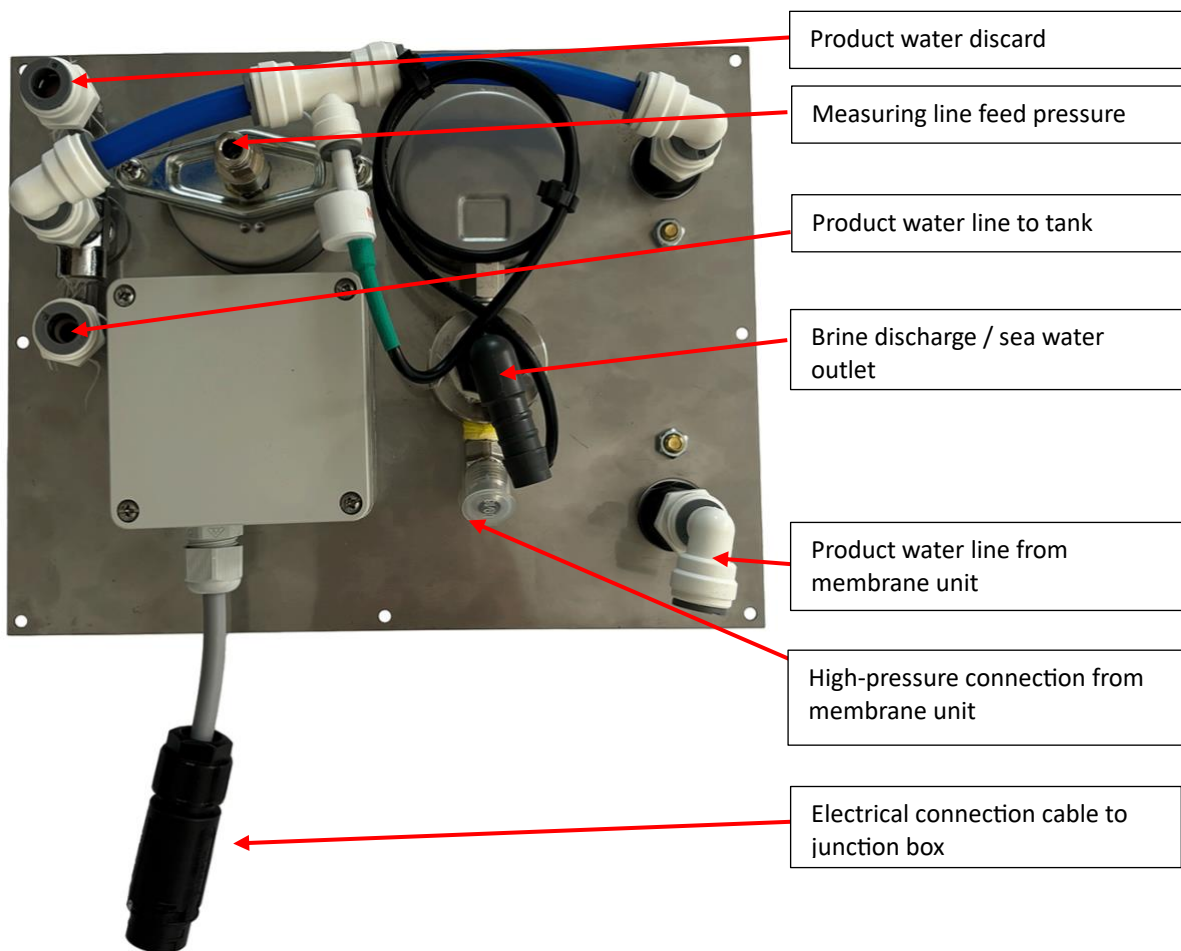



Illustration 8 – Connections to control panel

Mounting membrane unit

 <p>Hint!</p>	<p>In the state of delivery, the pressure vessels are sealed. Do not connect the high-pressure hoses until shortly before commissioning to prevent the membrane from drying out.</p>
--	--

Installation position: The membrane unit can be mounted in any position. In the case of vertical (upright) installation, the concentrate and product water outlet must be oriented upwards.

Attach the membrane unit via the pre-assembled mounting brackets using the included 5x20 screws.





To reduce vibrations, a damping underlay is recommended.

Due to the design, the pressure leads to a slight elongation of the tie rods and thus movement of the end plates. Accordingly, slotted holes are provided in the mounting brackets. Take this into account when choosing the attachment point and tightening the screws. The screws should be placed as centrally as possible in the slotted holes.



Illustration 9 – Membrane unit with connections for sea water and product water

Installation of hose lines

 Hint!	For all hose connections below the waterline, we recommend the use of two hose clamps per connection.
 Hint!	Kinks and constrictions in the hose lines must be avoided at all costs, as these can lead to damage to the system.
 Hint!	Use cable ties at regular intervals to avoid chafing. The edges of the drill holes on bulkhead penetrations must be rounded to avoid damage to cables and hoses. Depending on the material and condition, additional protection must also be provided on bulkhead penetrations
 Hint!	The product water pipe must never be completely closed during operation.

The supplied hose material include:

1. A suction hose with steel spiral for the feed line to the high-pressure pump, as well as for the salty wastewater from the pressure regulator to the through hull.
2. High Pressure hose 6m
3. 3/8" quick connect hose for product water
4. 6mm quick connect hose for measuring the pressure in the feed line

Cut the hose at right angles with a sharp knife without crushing it.
Avoid sharp bends

Sea water and flushing water lines

In order to keep pressure losses along the hose lines low, it is advisable to keep the hose lengths from the seacock to the high-pressure pump as well as the high-pressure hoses as short as possible.

Please take this into account when choosing the installation location and, if possible, do not use more than the supplied hose material for these sections.

Product water pipes

For the product water, remove the sealing plugs on the membrane unit and plug in the supplied 3/8" hose. Be sure to insert it completely to achieve a tight connection. From there, this is to be led to the inlet of the flow meter on the control panel. Two outlets for the product water must then be placed from the control panel. Once to the discard or test outlet and once to the tank.

High-pressure connection

Each system comes with a 6m high-pressure hose and two fittings for self-assembly. This is used to connect the high-pressure pump to the membrane unit as well as from the membrane unit to the pressure regulator on the control panel. The high-pressure hose must be cut and cut to length according to the requirements of the installation position. The supplied fittings must be mounted on the free ends.

Please check the required length carefully before cutting to length and take care to avoid sharp bending radii during installation.

A sharp knife is sufficient to cut the hose. Make sure to cut the hose at right angles.

Installation of high-pressure connections

Remove the sealing or protective caps on the high-pressure connections and connect the high-pressure hoses to the connection fittings.

It is recommended to grease the threads of the connection nipples to make it easier to loosen them later. However, avoid allowing grease to enter the water cycle.

The union nuts of the high-pressure hoses are to be tightened by hand and then tightened by a further 20-45°. The connection fitting on the membrane unit does not rotate with it due to the mounted retaining plates. At the control panel and the high-pressure pump the fittings must be held against each with a suitable key.

Installation of screw on fittings

To make it easier to install the fitting, please apply a little silicone grease to the outside of the hose end and to the inner nipple in advance.



Illustration 10 - Silicone grease-coated sheath and nipple

To install the screw fittings, the outer sleeve must first be screwed counterclockwise onto the hose. The correct screw-in depth is important here. The end of the hose should be in the sleeve just before the thread for the screw-in nipple.

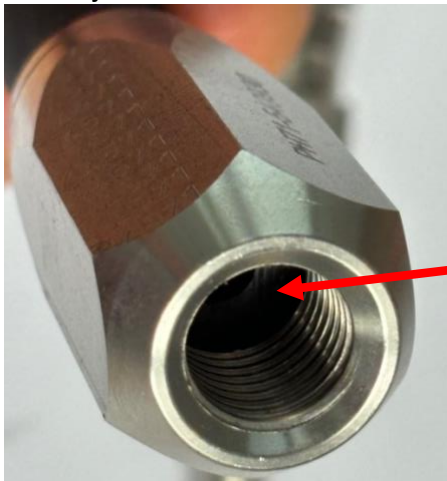

Hose end approx. 2-3 mm before the start of the thread

Illustration 11 - Pre-assembled screw socket

Now press the nipple of the fitting into the end of the hose until the threads of the sleeve and fitting touch. It can be helpful to place the nipple on a suitable, smooth surface so that it can be pressed in far enough.



Illustration 12 - Pressing the nipple into the hose with pre-assembled socket

Now screw the nipple clockwise into the sleeve. Hold the sleeve on the hose with a matching spanner to prevent it from twisting. Screw the nipple into the sleeve as far as it will go.





Illustration 13 - Hold on to the socket while screwing in the nipple



Illustration 14 - Correctly mounted screw fitting - socket and nipple are fully screwed together

Electrical connections

 <p>Hint!</p>	The electrical connection must be left to trained specialists.
 <p>Hint!</p>	The existing installation on board must have a RCD and this must be used for the selected connection of the junction box!

The included components are already wired and equipped with connectors allowing for a plug & play installation.

For the connectors, make sure to close them completely. The plugs can only be joined together in one position. Do not apply force.

Connections to be made:

- Connection cable HP pump to junction box
- Control cable of junction box to control panel
- Connection cable of feed pump from junction box to feed pump
- For Autoflush: Solenoid valve connection cable from junction box to solenoid valve
- Power plug for power supply with 230V

Excess cable lengths can be wound up and fixed. Alternatively, the cables can also be shortened. Disassembly of the connectors is possible.

To disconnect the connectors, the respective latching mechanism must be released:

- Motor connector: Push in the snap-in lug and disconnect the connector
- Plug to control panel: Rotate the locking ring to the position of the open lock symbol
- Feed pump and solenoid valve: No locking mechanism, disconnect the plug by pulling it.

8. Documentation Attachment

Electrical wiring diagram

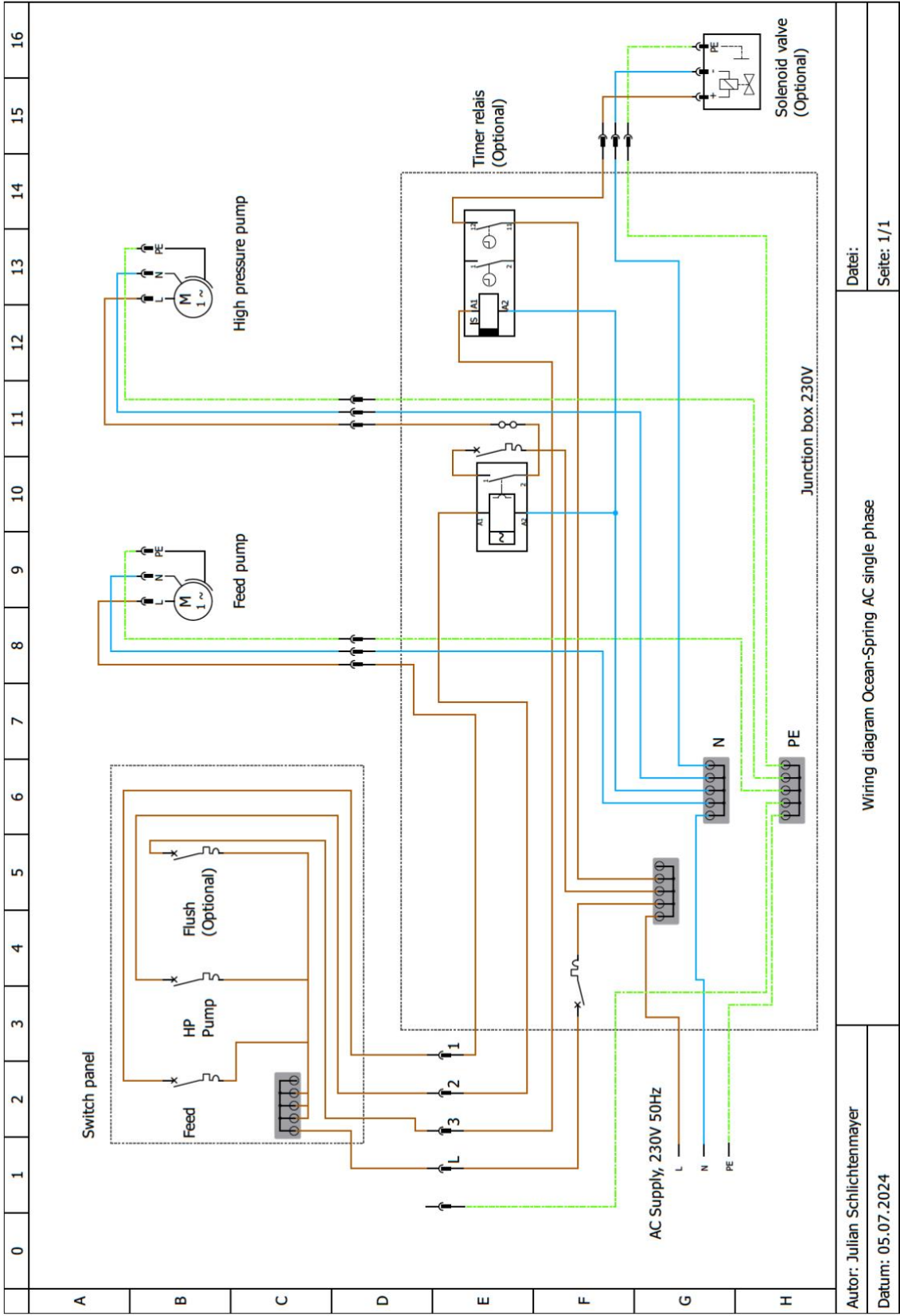

Autor: Julian Schlichtenmayer
Datum: 05.07.2024

Wiring diagram Ocean-Spring AC single phase

Datei:
Seite: 1/1

Illustration 15 - Wiring diagram electrical installation

Water Flow Chart

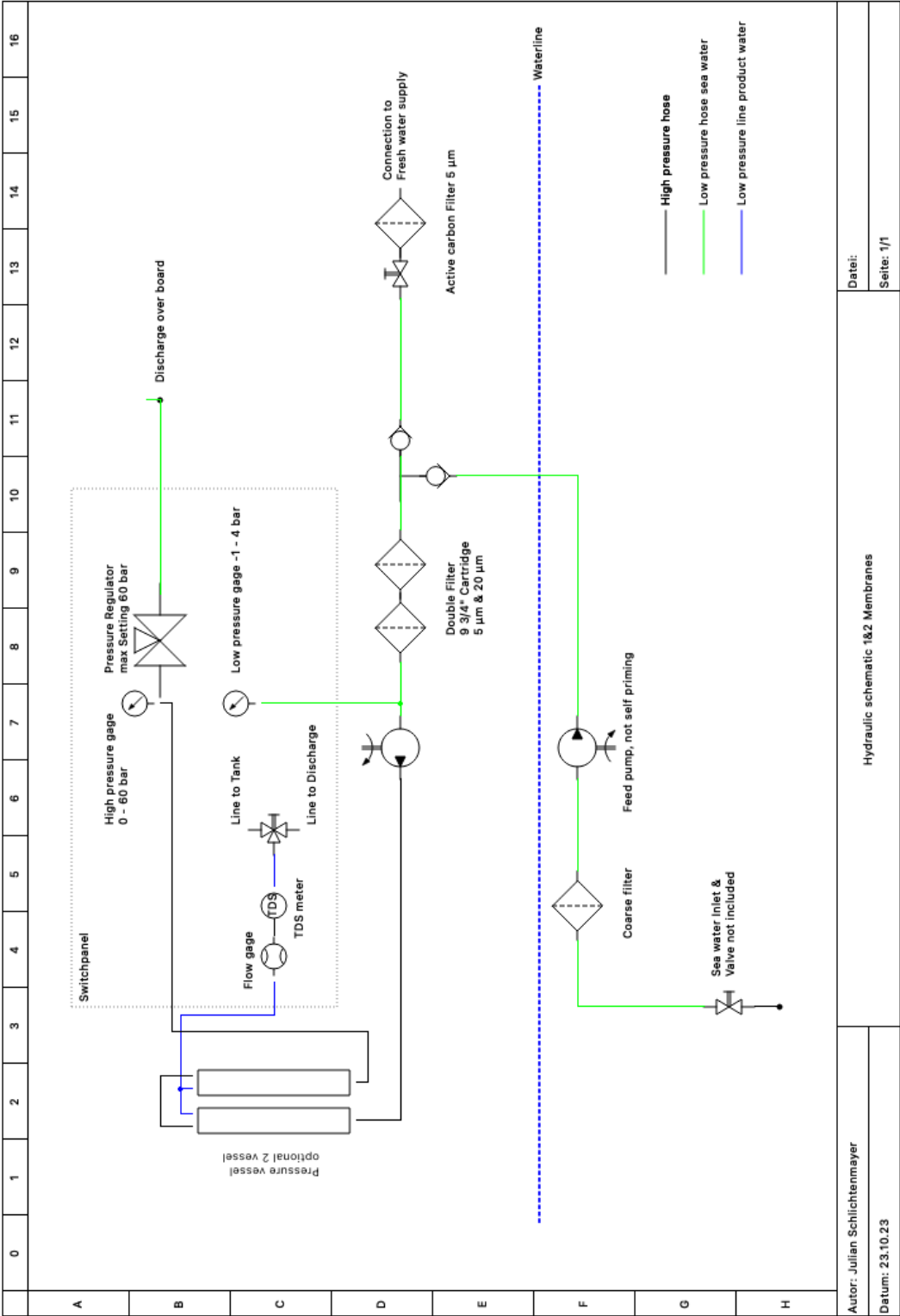

Illustration 16 - Hydraulic diagram

Autor: Julian Schlichtenmayer Datum: 23.10.23		Date: Seite: 1/1	
Hydraulic schematic 1&2 Membranes			

Dimensions of the main components

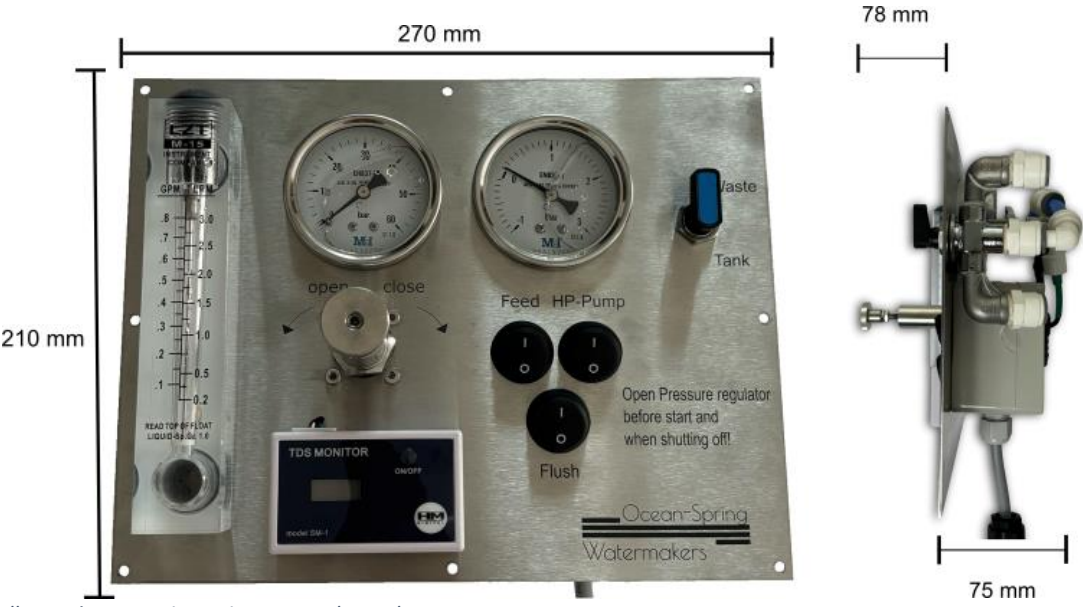

Illustration 17 - Dimensions control panel



Illustration 18 - Dimensions membrane unit 1x2540



Illustration 19 - Dimensions membrane unit 2x2540



Illustration 20 - Dimensions membrane unit 3x2540

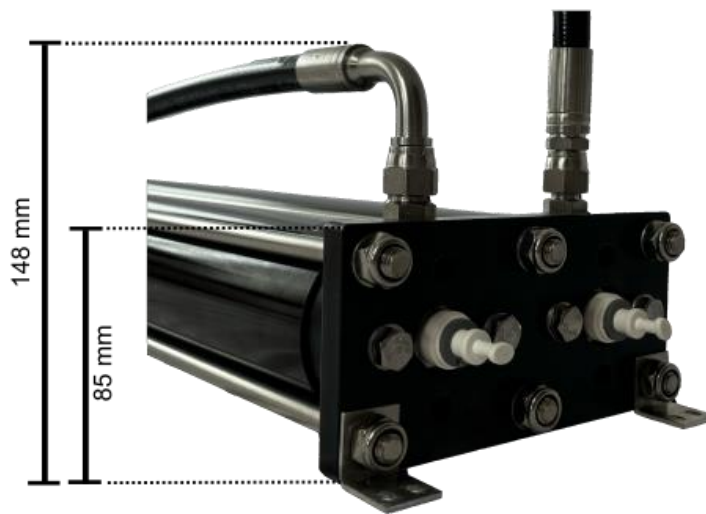

Illustration 21 - Height of membrane unit with connection options



Feed pump AC 65/110



Feed pump AC 80/130



Feed pump AC 160/200

Illustration 22 - Dimensions of the feed pump



Illustration 23 - Dimensions of the high-pressure pump unit

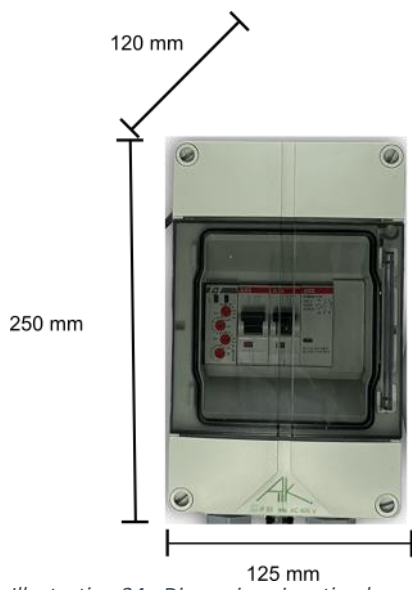

Illustration 24 - Dimensions junction box



Illustration 25 - Dimensions coarse dirt filter



Illustration 26 - Pre-filter housing dimensions



Illustration 27 - Dimensions filter flush water

Spare parts list high-pressure pump

EXPLODED VIEW

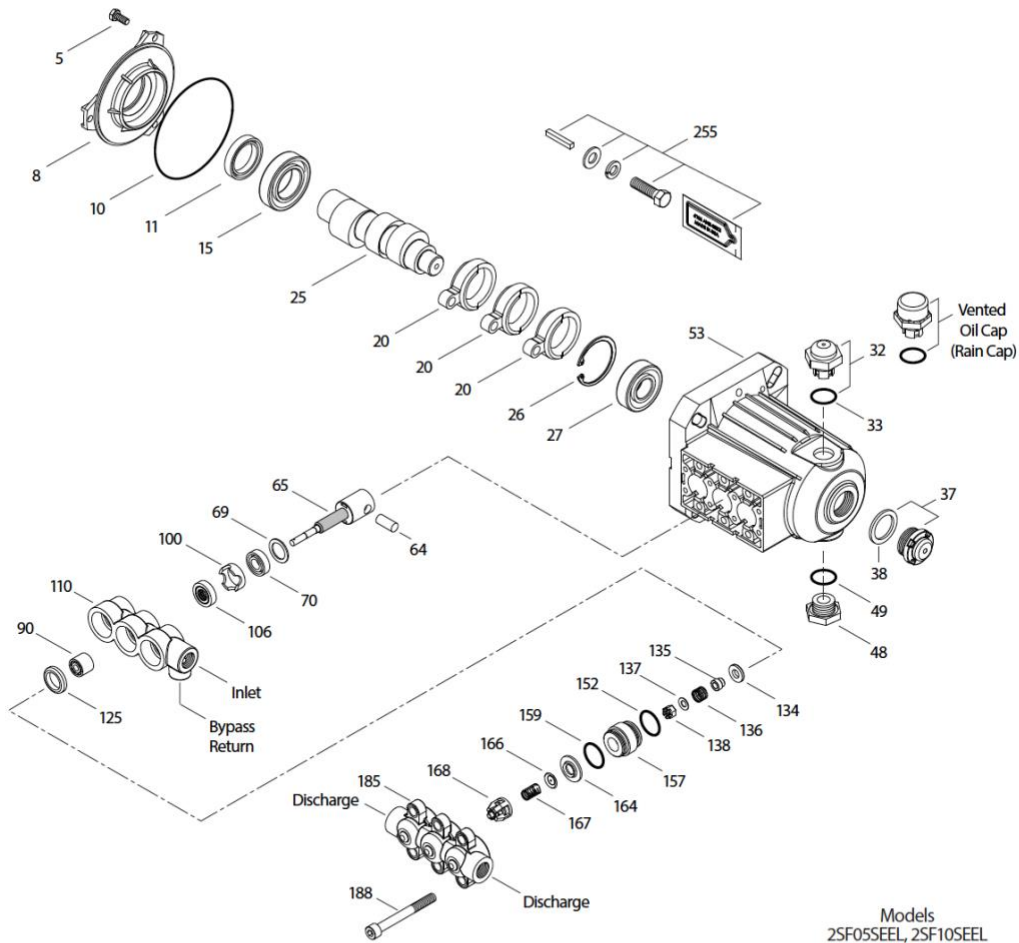

Models
2SF05SEEL, 2SF10SEEL
2SF15SEEL, 2SF22SEEL
February 2022

OPTIONAL PARTS AND ACCESSORIES

PART	DESCRIPTION	QTY
549726	Cap, Vented with O-Ring (Rain Cap)	1
80228	Screw, HH (M8 - 1.25 x 80 Full Thread) (See Tech Bulletin 055)	2
7501	Unloader, 3/8" Ports, 316 SS (Not Shown)	1
7501.100	Regulator, 3/8" Ports, 316 SS (Not Shown)	1
9960	Valve, Pop-Off, 1/4" Port, 316 SS (Not Shown)	1
990394	Kit, Oil Drain (Not Shown)	1

SERVICE PARTS

PART	DESCRIPTION	QTY
34973	Seal Kit - Standard NBR	1
34972	Discharge Valve Kit - Standard NBR	1
39668	Inlet Valve Kit - Standard NBR	1
6139	Lubricant, Anti-Seize (8 oz) (See Tech Bulletin 095) (Fill to Specified Crankcase Capacity Prior to Start-up)	1
6107	Oil, Bottle (21 oz)	1

Kits - NBR, FPM, EPDM, IPFE listed on Page 4.

Illustration 28 - Exploded view of high-pressure pump

PARTS LIST

ITEM	PART NUMBER	MATL	DESCRIPTION	MODEL	QTY
5	547445	S	Screw, HHC Sems (M6x14) (See Tech Bulletin 074, 092)	All	3
8	547153	AL	Cover, Bearing (See Tech Bulletin 092)	All	1
10	14041	NBR	O-Ring, Bearing Cover-70D (See Tech Bulletin 092)	All	1
11	55337	NBR	Seal, Oil, Crankshaft (See Tech Bulletin 092)	All	1
15	14488	STL	Bearing, Ball, Inner	All	1
20	547046	TNM	Rod, Connecting	All	3
25	831987	CM	Crankshaft, 1.8mm	05SEEL	1
	46109	CM	Crankshaft, 3.1mm	10SEEL	1
	44931	CM	Crankshaft, 4.5mm	15SEEL	1
	45160	CM	Crankshaft, 6.3mm	22SEEL	1
26	12385	STL	Ring, Retaining, Bearing	All	1
27	15710	STL	Bearing, Ball, Outer	All	1
32	547961	RTP	Cap, Oil Filler with O-Ring	All	1
33	14179	NBR	O-Ring, Oil Filler Cap-70D	All	1
37	92241	PC	Gauge, Oil with Gasket-80D (See Tech Bulletin 074)	All	1
38	44428	NBR	Gasket, Flat, Oil Gauge-80D	All	1
48	44842	NY	Plug, Drain	All	1
49	14179	NBR	O-Ring, Drain Plug-70D	All	1
53	547285	AL	Crankcase (See Tech Bulletin 092)	All	1
64	16948	CM	Pin, Crosshead	All	3
65	834203	SSTO	Rod, Plunger (See Tech Bulletin 124)	All	3
69	126259	STCP R	Washer, Oil Seal	All	3
70	25461	NBR	Seal, Oil Crankcase	All	3
90	544697	CC	Plunger, Ceramic (M18 x 18)	All	3
100	44869	PVDF	Retainer, Seal	All	3
106	547683	NBR	Seal, Low-Pressure, with SS-Spring	All	3
110	547704	SS	Manifold, Inlet	All	1
125	44652	SNG	Seal, High-Pressure, with SS-Support	All	3
134	543691	SS	Valve, Inlet (See Tech Bulletin 091)	All	3
135	543689	SS	Spacer	All	3
136	543690	SS	Spring, Inlet Valve	All	3
137	88575	S	Washer, Conical (M6)	All	3
138	543692	SS	Nut (M6)	All	3
152	† 26089	NBR	O-Ring, Adapter Spacer, Inner-80D	All	3
157	544700	SS	Adapter, Valve	All	3
159	† 26089	NBR	O-Ring, Adapter Spacer, Outer-80D	All	3
164	544293	SS	Seat	All	3
166	543669	SS	Valve	All	3
167	543700	SS	Spring	All	3
168	44565	PVDF	Retainer, Spring	All	3
185	547705	SS	Manifold, Discharge	All	1
188	544701	S	Screw, HSH (M8 x 80) (See Tech Bulletin 074)	All	6
255	30517	STZP R	Assembly, Bolt Mount	All	1

Bold print part numbers are unique to a particular pump model. † Production parts are different than repair parts.
 R Components comply with RoHS Directive. For additional technical information see www.catpumps.com/literature/tech-bulletins.
 NOTE: Discard Key that may come standard with most motors and engines and use only the key included in Bolt kit. MATERIAL CODES (Not Part of Part Number):
 AL=Aluminum CC=Ceramic CM=Chrome-Moly D=Acetal EPDM=Ethylene Propylene Diene Monomer FPM=Fluorocarbon
 HT=Hi-Temp (EPDM Alternative) IPFE=Perfluoroelastomer NBR=Medium Nitrile (Buna-N) NY=Nylon PC=Poly Carbonate PVDF=Polyvinylidene Fluoride
 RTP=Reinforced Composite S=304SS SNG=Special Blend (Buna) SS=316SS SSTO=316SS/Titanium Oxide ST=Special PTFE ST4=Special PTFE 4
 STL=Steel STCP=Steel/Chrome Plated STZP=Steel/Zinc Plated TNM=Special High Strength

Optional Parts and Accessories and Service parts listed on Page 3. Standard and optional Seal Kits and Valve Kits listed on page 4.

Illustration 29 - Component list high-pressure pump